

REV.	DESCRIPTION	DATE
A	NEW DRAWING	12/1/2008

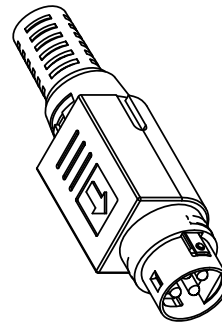

SCALE: 1:2

TOLERANCE:
±0.2mm UNLESS OTHERWISE
SPECIFIED

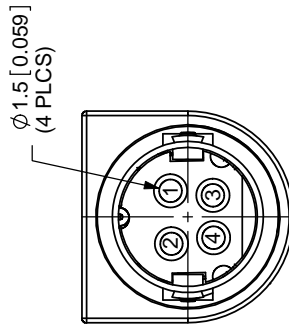
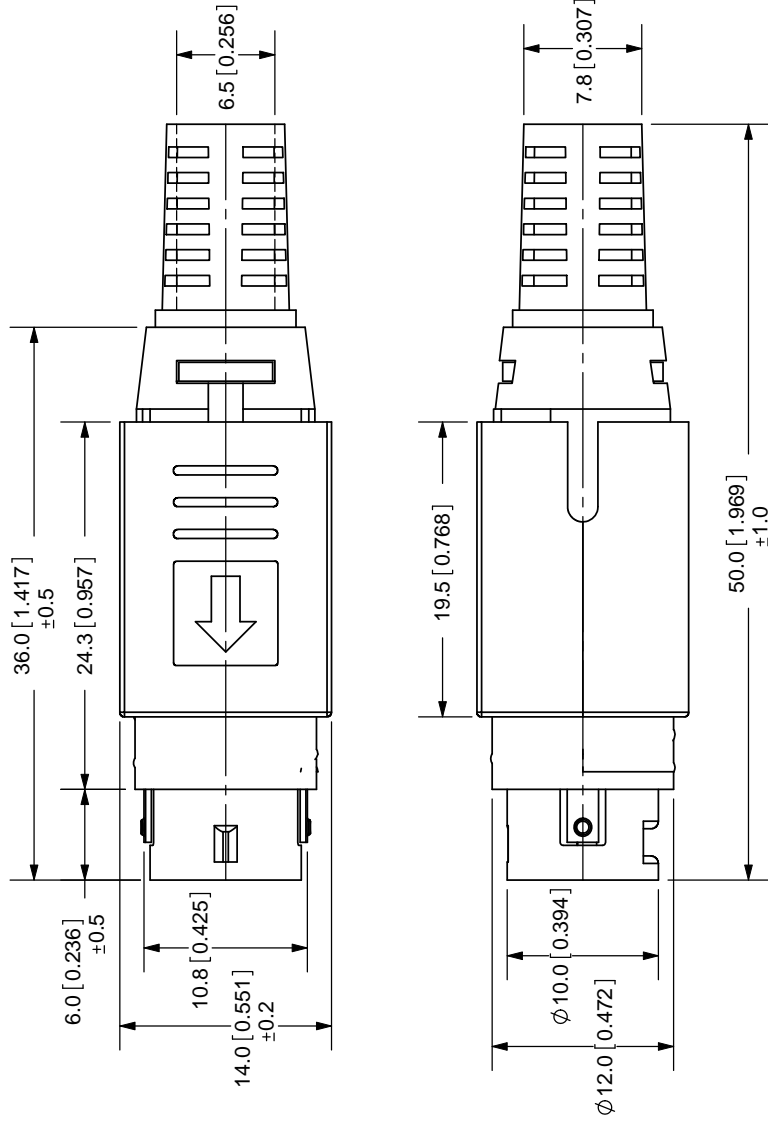

SPECIFICATIONS:
RATING: 20V DC @ 7.5A
INSULATION RESISTANCE: 50M OHMS MIN: 250V DC
VOLTAGE WITHSTAND: 250V AC R.M.S. FOR 1 MINUTE
LIFE: 5,000 CYCLES





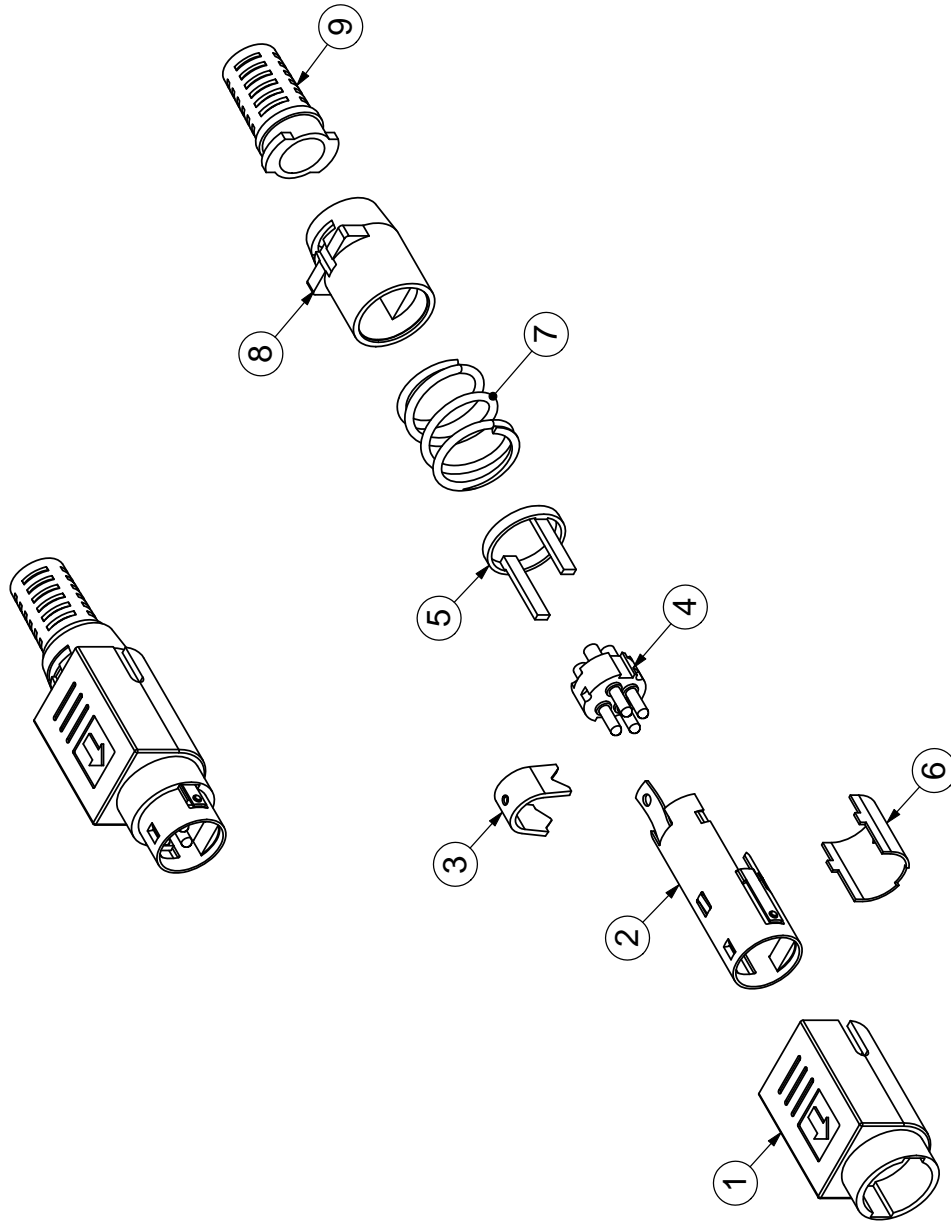

MATERIAL	PLATING
OUTER HOOD	ABS
METAL SLEEVE	Brass
CLAMP	Brass
PIN/BODY	Brass/PBT
PLASTIC RING	POM
METAL COVER	Brass
SPRING	Steel
INNER HOOD	ABS
STRAIN RELIEF	PVC

20050 SW 112th Ave.
Tualatin, OR 97062
Phone: 503-612-2300
800-275-4899
Fax: 503-612-2383
Website: www.cui.com

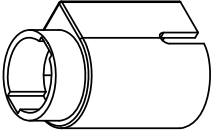
TITLE: 4-PIN POWER DIN PLUG	REV: A
PART NO: PDP-40	UNITS: MM [INCHES]
DRAWN BY: ZRJ	APPROVED BY:
	SCALE: 2:1

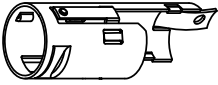
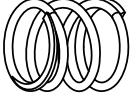

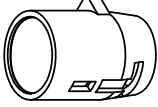
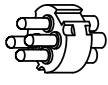
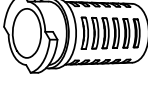
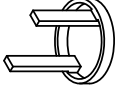
1	outer hood		9	metal cover	
2	metal sleeve		7	spring	
3	clamp		8	inner hood	
4	pin body		6	strain relief	
5	plastic ring				

REV: A	TITLE: 4-PIN POWER DIN PLUG
UNITS: MM [INCHES]	PART NO: PDP-40
SCALE: 1:1	DRAWN BY: ZRJ
APPROVED BY:	

STEP 1
insert strain relief (9),
inner hood (8), and
spring (7) onto cable

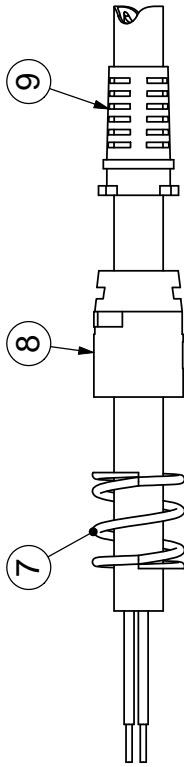

STEP 2
solder wires to
contacts on pin body (4)

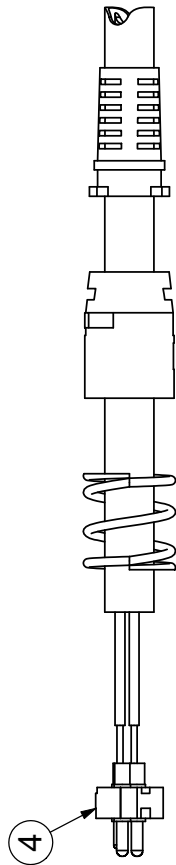

STEP 3
push pin body (4)
and plastic ring (5)
into metal sleeve (2)

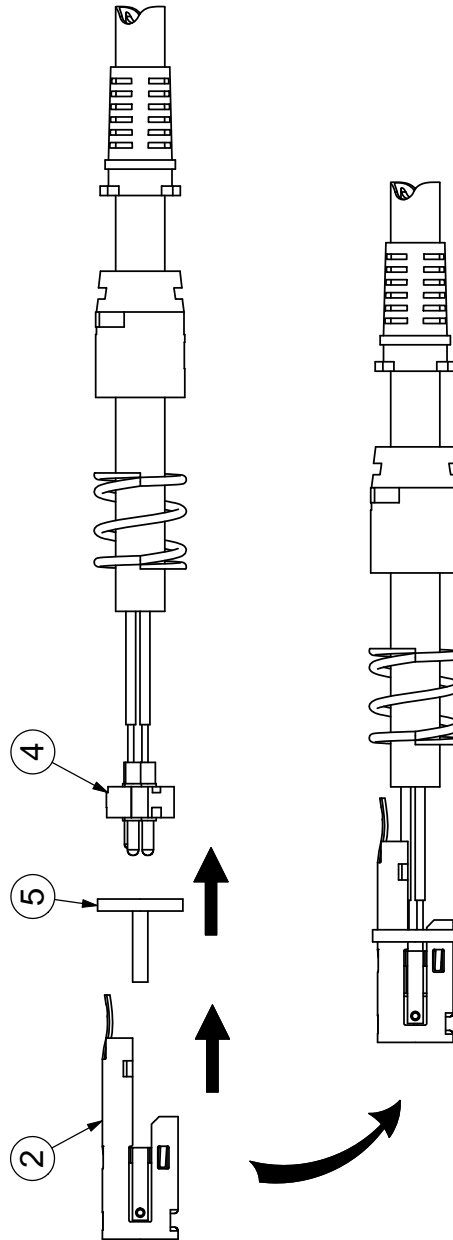

TITLE: 4-PIN POWER DIN PLUG	REV: A
PART NO: PDP-40	UNITS: MM [INCHES]
DRAWN BY: ZRJ	APPROVED BY:
	SCALE: 1:1

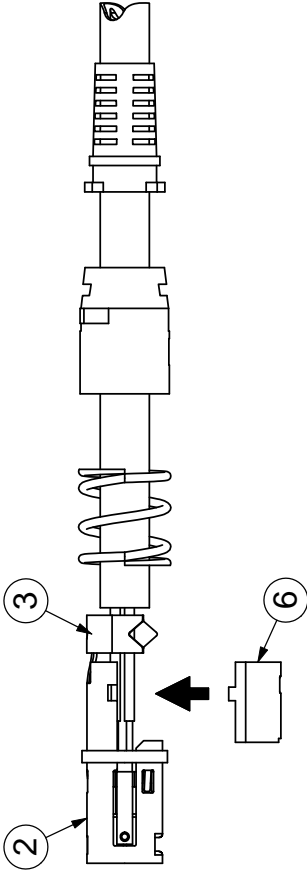

STEP 4
crimp the clamp (3)
onto wires, assemble
metal cover (6) onto
metal sleeve (2)

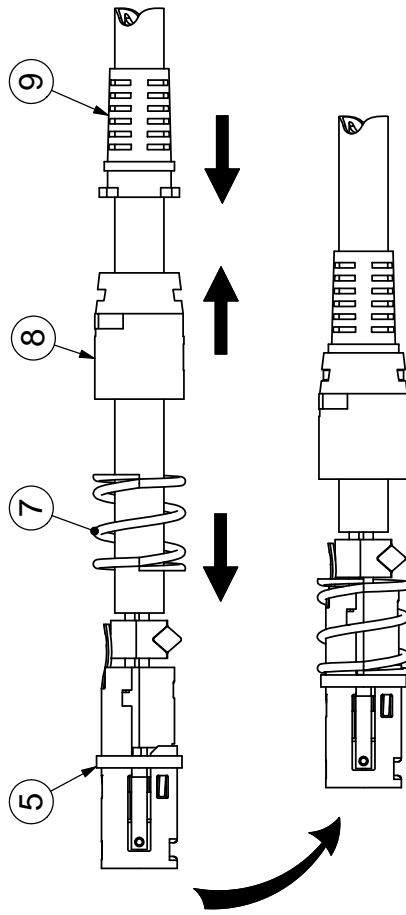

STEP 5
push spring (7) up
to plastic ring (5),
assemble inner hood (8)
and strain relief (9)
together

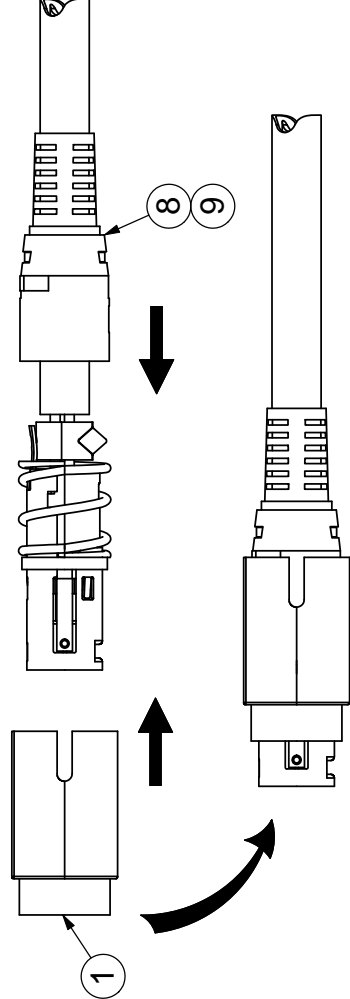

STEP 6
push outer hood (1)
and inner hood/
strain relief (8,9)
together

TITLE: 4-PIN POWER DIN PLUG	REV: A
PART NO: PDP-40	UNITS: MM [INCHES]
DRAWN BY: ZRJ	APPROVED BY:
	SCALE: 1:1